



ROBEX 360LC-7A

Standard Equipment

- ISO standard cabin**
- Heater & Defroster
 - Heater (7,500 kcal/hr, 30,000 BTU/hr)
 - All-weather steel cab with all-around visibility
 - Safety glass windows
 - Rise-up type windshield wiper
 - Sliding fold-in front window
 - Sliding side window
 - Lockable door
 - Hot & cool box
 - Accessory box & Ash-tray

- Computer Aided Power Optimization(New CAPO) system**
- 2-power mode, 3-work mode, 2-user mode
 - Auto deceleration & one touch deceleration system
 - Auto warm up system
 - Auto overheat prevention system

- Heater & Defroster (7500 Kcal/hr, 30000 BTU/hr)**
- Self diagnostic system**
- AM/FM radio and cassette**
- Radio remote switch

- Centralized monitoring**
- LCD display
 - Engine speed
 - Clock & Error code
 - Gauges
 - Fuel level gauge
 - Engine coolant temperature gauge
 - Hyd. oil temperature gauge
 - Warning
 - Fuel level
 - Check Engine & CPU
 - Engine oil pressure
 - Engine coolant temperature
 - Hyd. oil temperature
 - Low battery
 - Air cleaner clogging
 - Indicator
 - Power max.
 - Preheat & Engine warming-up
 - One touch decel

- Starting Aid (Air gride heater) cold Weather**
- Door and cab locks, one key**
- Two outside rearview mirrors**
- Fully adjustable suspension seat with seat belt**
- Slidable joystic, pilot-operated**
- Console box tilting system(LH.)**
- Three front working lights**
- Electric horn**
- Batteries (2 x 12 V x 160 AH)**
- Battery master switch**
- Removable clean out screen for Hyd. oil cooler**
- Automatic swing brake**
- Removable reservoir tank**
- Water saporator & Fuel pre-filter, Fuel line**
- Boom holding system**
- Arm holding system**
- Counterweight (6500 kg, 14330 lb)**
- Mono boom (6.5 m, 21' 4")**
- Arm (3.2 m, 10' 6")**
- Track shoes (600 mm, 23.6")**
- Track rail guard**
- Travel alarm**
- Fuel warmer**

Optional Equipment

- Air-conditioner(5,000 kcal/hr, 20,000 BTU/hr)**
- FATC (Full Automatic Temperature Control)**
- Sun visor for cabin inside**
- Fuel filler pump(35 ℓ /min, 9.2 USgpm)**
- Beacon lamp**
- Safety lock valve for boom cylinder with overload warning device**
- Safety lock valve for arm cylinder**
- Single acting piping kit(breaker, etc)**
- Double acting piping kit(cramshell, etc)**
- Accumulator, work equipment loweringling**
- 12 volt power supply(24V DC - 12V DC converter)**
- Electric transducer**
- CD Player**
- Various optional Arms**
- Short arm (2.50 m, 8' 2")
 - Long arm (3.90 m, 12' 10")
 - Long arm (4.30 m, 14' 1")
 - Super long arm (5.10 m, 16' 9")

- Various optional Buckets(SAE heaped)**
- Standard bucket(1.62 m³, 2.12 yd³)
 - Narrow bucket(1.15 m³, 1.5 yd³)
 - Narrow bucket(1.46 m³, 1.91 yd³)
 - Light duty bucket(1.86 m³, 2.43 yd³)
 - Light duty bucket(2.10 m³, 2.75 yd³)
 - Light duty bucket(2.32 m³, 3.03 yd³)
 - Heavy duty bucket(1.62 m³, 2.12 yd³)
 - Rock bucket(1.44 m³, 1.88yd³)
 - Rock bucket(1.62 m³, 2.12 yd³)
 - Rock bucket(1.86 m³, 2.43 yd³)

- Cabin lights**
- Cabin FOPS/FOG (ISO 10262)**
- Cabin Roof-Cover Transparent**
- Track shoes**
- Triple grousers shoe (700mm, 28")
 - Triple grousers shoe (750mm, 30")
 - Triple grousers shoe (800mm, 32")
 - Triple grousers shoe (900mm, 36")

- Tropical kit**
- Fan drive ratio (1.1:1)
 - Louver side cover (R/H)
- Lower frame under cover**
- Full track guard**
- Preheating system**
- Tool kit**
- Operator suit**

- Mechanical suspension seat with heated**
- Adjustable air suspension seat

Robex NEW 7A SERIES

360LC-7A

CRAWLER EXCAVATOR Applied *Tier III* Engine
CUMMINS QSL Engine : 296 HP(221 kW) / 1,850 rpm
Operating Weight : 36,100 ~ 37,400 kg (79,590 ~ 82,500 lb)
Bucket Capacity, SAE : 1.15 ~ 2.32 m³ (1.5 ~ 3.03 yd³)

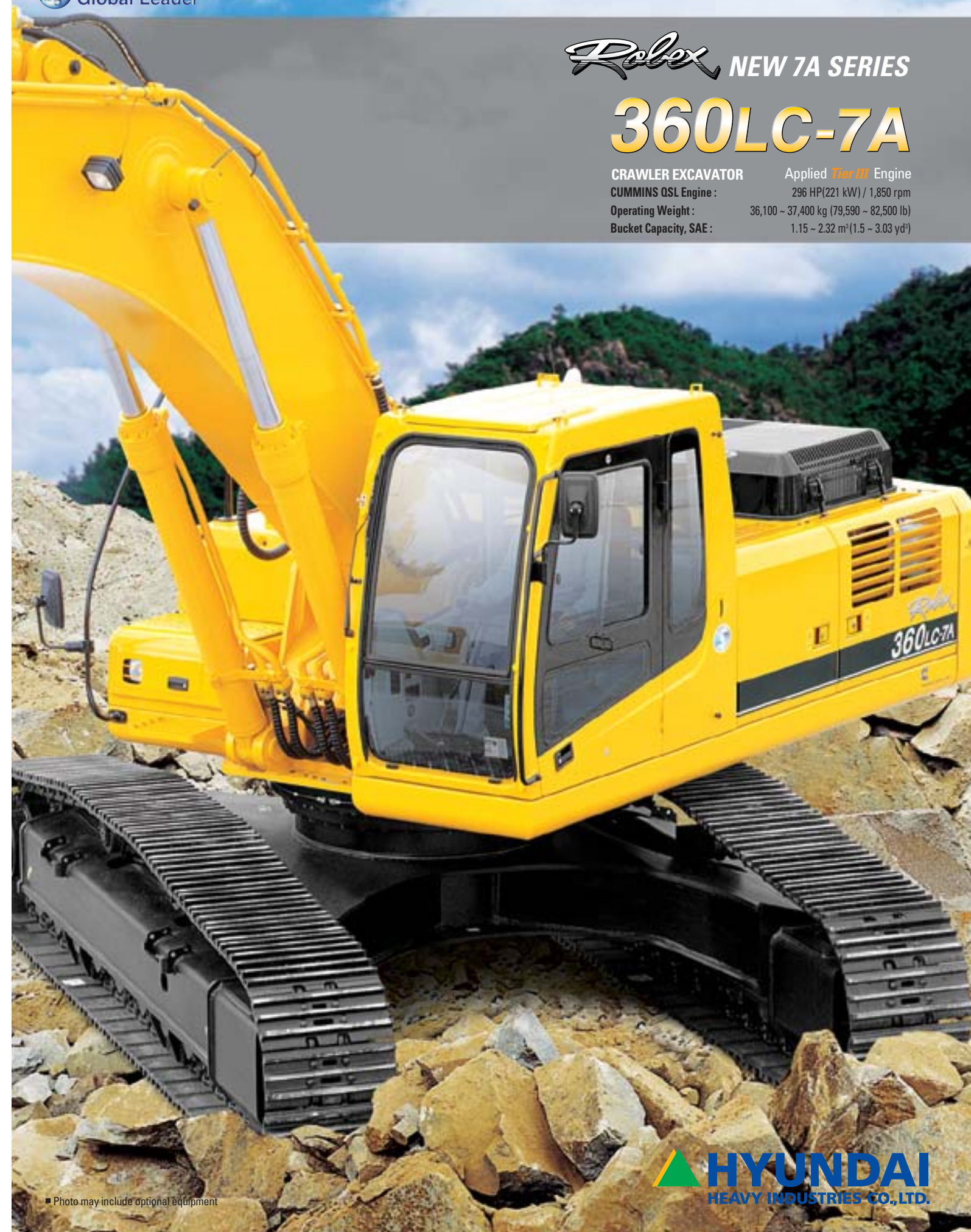

Photo may include optional equipment

Standard and optional equipment may vary. Contact your Hyundai dealer for more information. The machine shown may vary according to International standards.

All US measurement rounded off to nearest pounds or inches.

HYUNDAI
HEAVY INDUSTRIES CO.,LTD.
 CONSTRUCTION EQUIPMENT DIVISION

Head Office (Sales Office) 1 CHEONHA-DONG, DONG-KU, ULSAN, KOREA
 Tel: (82) (52) 230-7970, 7729 Fax: (82) (52) 230-7979, 7720

U.S. Operation Hyundai Construction Equipment U.S.A., Inc.
 955 ESTES AVENUE, ELK GROVE VILLAGE IL, 60007
 Tel: (1) 847-437-3333 Fax: (1) 847-437-3574

European Operation Hyundai Heavy Industries Europe N.V.
 VOSSENDAAL 11, 2440 GEEL, BELGIUM
 Tel: (32) 14-562200 Fax: (32) 14-593405 ~ 06

PLEASE CONTACT

www.hyundai-ce.com

2006. 09 Rev 0

HYUNDAI
 HEAVY INDUSTRIES CO.,LTD.

Built for Maximum Power, Performance, Reliability.

A new chapter in construction equipment has now begun.
Making the dream a reality.

Robex 360LC-7A



Operator's Comfort is Foremost. Wide Cab Exceeds Industry Standards.

Technology in Cab Design



Visibility

- Even more visibility than before, for safer, more efficient operating.



Excellent Ventilation

- Ventilation has been improved by the addition of the larger fresh air intake system, and by providing additional air flow throughout the cab.
- Sliding front and side windows provide improved ventilation.
- A large sunroof offers upward visibility and additional ventilation.



Comfortable Operator Environment

- The control levers and seat can be adjusted to provide maximum operator comfort.
- The seat is fully adjustable for optimum operating position, reducing operator fatigue.
- Console boxes slide forward and backward for improved accessibility.
- The proportional pressure controls reduce unnecessary exertion while ensuring precise operation.
- Large windows allow excellent visibility in all directions.



Low noise design

- The Robex 7series was designed with low operation noise in mind.
- Hyundai engineering helps to keep interior and exterior noise levels to a minimum.
- The cab's noise levels have been additionally reduced by improving the door seals for the cab and engine compartments.
- An insulated diesel engine compartment with sound-damping material also reduces noise.



- 1 Wide, Comfortable Operating Space
- 2 Steel Cover Sunroof
- 3 Dial Type Engine Speed Switch and / Key Switch

Remote Radio Control and Deluxe Cassette



Robex 360LC-7A



Improved Intelligent Display
Instrument Panel is installed in front of RH console box. It is easy to check all critical systems with easy-to-read indicators.

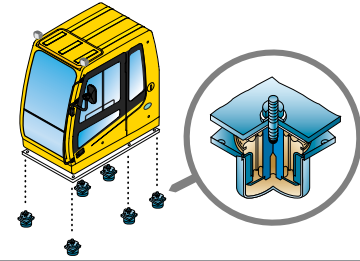

Minimization of Shock and Vibration through Cab Mounting System
The application of Viscous Mounting to the cabin support provides the operator with a much improved ride. The operator work efficiency will increase as the shock and noise level in the cabin decreases.



Operating Environment

Maximum Protection



▲ Storage box and Cup Holder
An Additional storage box and cup holder are located behind operator's seat, and it keeps food and beverages cool or hot.

◀ Wide Cab with Excellent Visibility
The cab is roomy and ergonomically designed with low noise level and good visibility. A full view front window and large rear and side windows provide excellent visibility in all directions.



Highly Sensitive Joystick and Easy Entrance
New joystick grips for precise control have been equipped with double switches.

- Left Power boost
- One touch deceleration
- Right Horn/Optional



Easy-to-Reach Control Panels
Switches and other essential controls are located near the operator. This helps keep operator movement to a minimum, enhancing control with less operator fatigue.



Rear Emergency Exit Window
Rear Exit Window is designed with easy exit for operator's safety.



Raise-up Wiper and Cabin Lights
Raise-up wiper has enhanced for the better front view. Cabin Lights enhances safety by brightly lighting the surroundings during night work(optional)



Wide, Comfortable Operating Space
All the controls are designed and positioned according to the latest ergonomic research. Reinforced pillars have also been added for greater cab rigidity.

Smooth Travel Pedal and Foot Rests

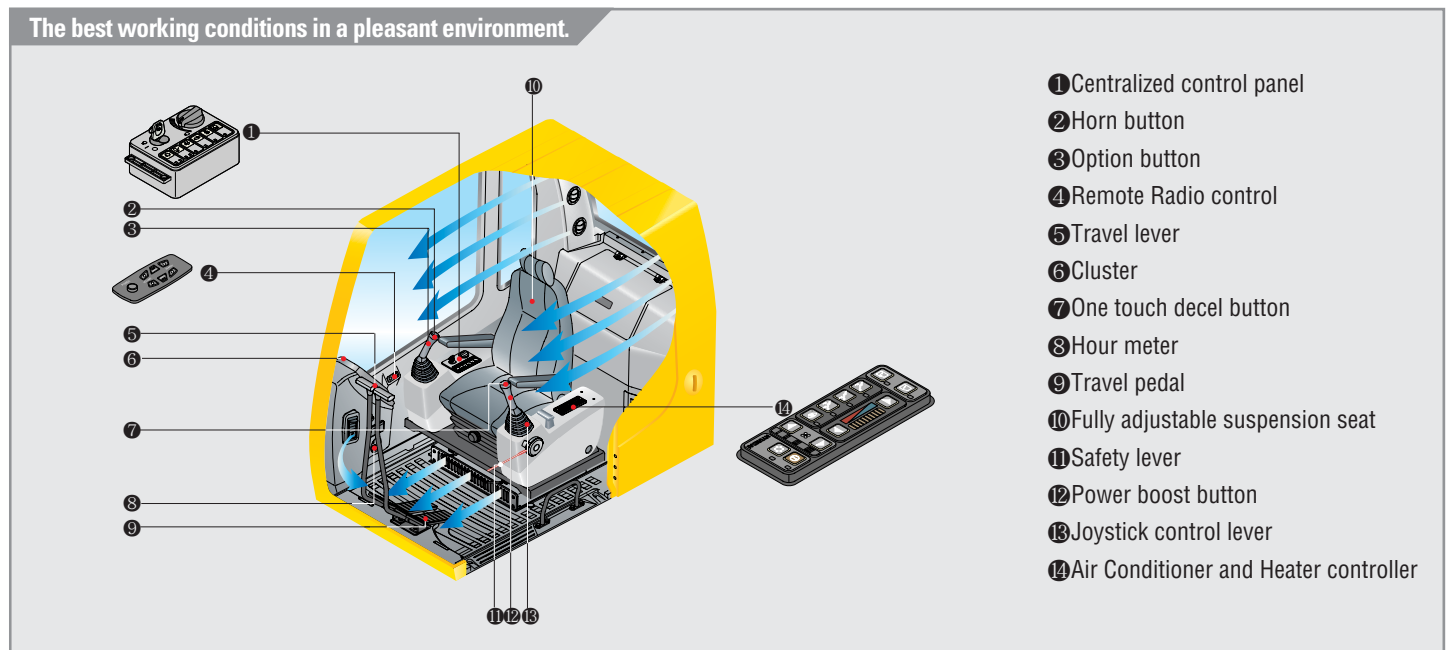



Automatic Engine Overheat Prevention

If the engine coolant temperature gets too high, the CPU controller lowers the engine speed and cools the engine.



Anti Restart System

The new system protects the starter from re-starting during engine operation, even if the operator accidentally turns the start key again.



Power boost control System

When the power boost system is activated, digging power increases about 10%. It is especially useful when extra power is temporarily needed, for instance, when digging hard earth and rock, or if the bucket teeth are stopped by a stubborn tree root.

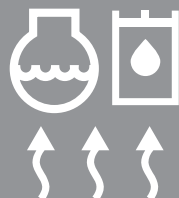

Automatic Warming-up System

After the engine is started, if the engine coolant temperature is low, the CPU controller increases the engine speed and automatically increases the pump flow rate to warm up the engine more effectively.

CUMMINS QSL Engine

The six cylinder 4 cycle Turbo Charged Engine with Charged Air Cooling, Has High Power output, Reliability, economical, and low emission. This engine meets Tier III emissions regulations.

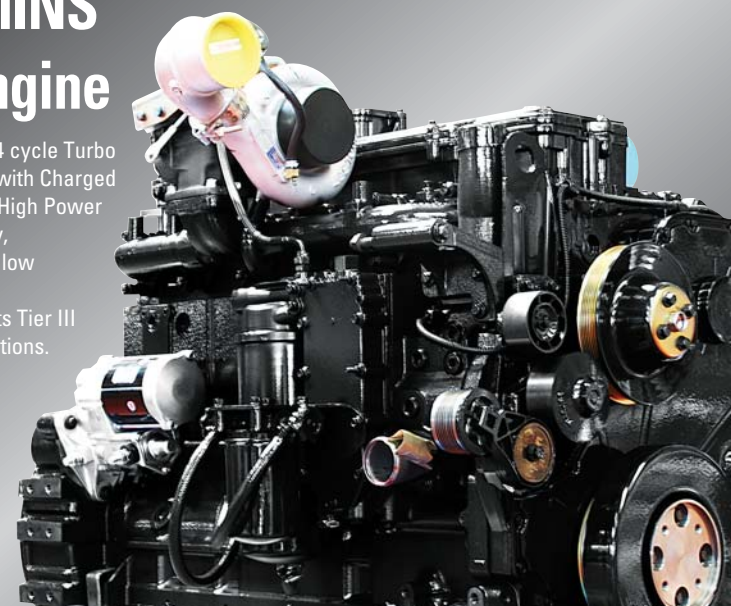

Heavy-duty strength

Everyone who's ever worked on construction equipment knows, there is no substitute for power and durability. The QSL handles the toughest loads and the roughest work conditions. At the same time, it delivers better fuel economy, has better cold starting capability and is up to 50% quieter in operation. Plus, the heavy-duty design of the QSL engine block and components such as articulated pistons, enhanced camshaft and roller cam followers, viscous damper and high capacity lube system add reliability and durability you can count on every day, year after year. Both fuel-efficiency and response are significantly enhanced with Cummins high pressure common rail fuel system. The system delivers high pressure injection independent of engine speed for optimum performance and flexibility at every rpm.

Advanced Hydraulic System

ADVANCED CAPO SYSTEM

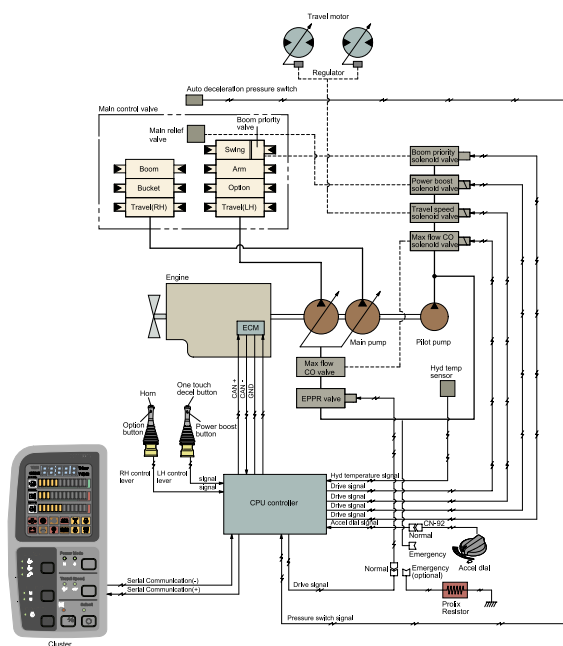

The advanced CAPO (Computer Aided Power Optimization) system maintains engine and mutual pump power at optimum levels. Mode selections are designed for various work loads and maintaining high performance while reducing fuel consumption. Features such as auto deceleration and power boost are included in the system. The system monitors engine speed, coolant temperature, and hydraulic oil temperature. Contained within the system are self diagnostic capabilities which are displayed by error codes on the cluster.

Self Diagnosis System

The CPU controller diagnoses problems in the CAPO system caused by electric and hydraulic malfunctions and displays them on the LCD monitor of the cluster through error codes. This controller has the capacity to identify 48 distinct types of errors. As the information from this device, such as engine rpm, main pump delivery pressure, battery voltage, hyd. temperature, and the state of all types of electric switches, provides the operator with a much more exact state of machine operating condition. This makes the machine easier to troubleshoot when anything does go wrong.

One Touch Decel System

When the one touch decel switch is pressed, CPU controller controls the accel actuator to reduce engine speed to 800 rpm. And then the one touch decel switch is pressed again, the engine speed recovers.

Pump Flow Control System

In neutral position: Pump flow is reduced to a minimum to eliminate power loss. In operation: Maximum pump flow is delivered to the actuator to increase the speed. With movement of the control lever, pump flow is automatically adjusted and the actuator speed can be proportionally controlled.

Boom & Arm Holding System

The Holding valves in the main control valve prevents the boom & arm from dropping over an extended period in neutral position.

Arm Flow Regeneration System

Arm flow regeneration valve provides smooth arm-in operation without cavitation.

Hydraulic Damper in Travel Pedal

Improved travel controllability & feeling by shock reducing when starting and stopping.

Increased Higher Performance



Reinforced Bucket and Bucket Linkage

Sealed and adjustable bucket linkage provides less wear of pins and bushes as well as silent operation. The design includes bucket link durability and anti wear characteristics. Additional reinforcement plates on cutting edge section. Reinforced bucket is made with thicker steel and additional lateral plate.



Strong and Stable Lower Frame

Reinforced box-section frame is all welded, low-stress, high-strength steel. It guarantees safety and resistance against external impact when driving on rough ground and working on wet sites through high tensile strength steel panels, with highly durable upper and lower rollers and track guards. Long undercarriage incorporates heavy duty excavator style components. X-leg type center frame is integrally welded for maximum strength and durability.

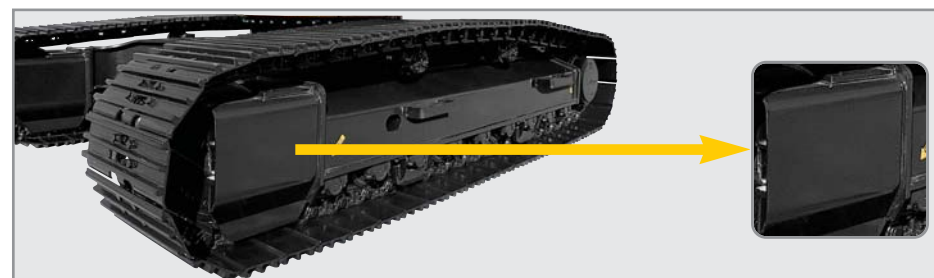

Track Rail Guide & Adjusters

Durable track rail guides keep track links in place. Track adjustment is made easy with standard grease cylinder track adjusters and shock absorbing springs. (Full Track Guide : Option)

Powerful and Preciser Swing Control

Improved shock absorbing characteristics make stopping a precise and smooth action



NEW MODE CONTROL SYSTEM



- POWER MODE**
H mode: High power S mode: Standard power
- WORK MODE**
M: Heavy duty work U: General work B: Breaker
- USER MODE**
M mode: Maximum Power
U mode: Memorizing Operator's Preferable Power Setting

Auto Deceleration System



When remote-control valves are in neutral position more than 4 seconds, CPU controller instructs the accel actuator to reduce engine speed to 1100rpm. This decreases fuel consumption and reduces cab noise levels.

Max. Flow Cut-off System

For precise control and finishing work, the Max. Flow Cut-off System reduces pump flow, thus allowing smooth operation.

Full open doors and master key system provide easy access for servicing.

Reliability & Serviceability



Side Cover with Left & Right Swing Open Type

Easy access to vital components gives unrestricted view of component allows easy maintenance and repair.



Easy to maintain engine components

The cooling and preheating system are provided for optimum and immediate operation, guaranteeing longer life for the engine and hydraulic components. Servicing of the engine and hydraulics is considerably simplified due to total accessibility.



Centralized Electric Control Box and Easy Change Air Cleaner Assembly

Electric control box and Air cleaner are centralized in one or the same compartment for easy service.



Highly efficient Hydraulic Pump

Pump output capacity has been increased.



Large tool box for extra storage



Durability of structure proven through FEM (Finite Element Method) analysis and long term durability test.

Engine

Model		Cummins QSL	
Type		Water cooled, 4 cycle Diesel, 6-Cylinders in line, direct injection, turbocharged, charger air cooler/ low emission	
Rated flywheel horse power	SAE	J1995 (gross)	296 HP (221 kW) at 1,850 rpm
		J1349 (net)	271 HP (202 kW) at 1,850 rpm
	DIN	6271/1 (gross)	300 PS (221 kW) at 1,850 rpm
		6271/1 (net)	275 PS (202 kW) at 1,850 rpm
Max. torque		138.3 kgf·m(1000 lbf·ft) at 1,400 rpm	
Bore x stroke		114 x 144.5 mm (4.5" x 5.3")	
Piston		8,900 cc (540 cu in)	
Batteries		2 x 12 V x 160 AH	
Starting motor		24 V, 7.5kW	
Alternator		24V, 50 Amp	

Hydraulic system

Main pump	
Type	Two variable displacement piston pumps
Max. flow	2 × 288 ℓ /min (76.6 US gpm / 63.8 UK gpm)
Sub-pump for pilot circuit	Gear pump
Cross-sensing and fuel saving pump system	
Hydraulic motors	
Travel	Two speed axial piston motor with brake valve and parking brake
Swing	Axial piston motor with automatic brake
Relief valve setting	
Implement circuits	330 kgf/cm ² (4,690 psi)
Travel	360 kgf/cm ² (4,765 psi)
Power boost (boom, arm, bucket)	360 kgf/cm ² (5,120 psi)
Swing circuit	260 kgf/cm ² (3,700 psi)
Pilot circuit	35 kgf/cm ² (500 psi)
Service valve	Installed
Hydraulic cylinders	
No. of cylinder-bore x rod x stroke	Boom: 2-160 × 110 × 1,500 mm (6.3" × 4.2" × 59.1")
	Arm: 1-170 × 120 × 1,760 mm (6.7" × 4.7" × 69.3")
	Bucket: 1-150 × 105 × 1,295 mm (5.9" × 4.1" × 51.0")

Drives & Brakes

Drive method	Fully hydrostatic type
Drive motor	Axial piston motor, in-shoe design
Reduction system	Planetary reduction gear
Max. drawbar pull	31,000 kgf (68,350 lbf)
Max. travel speed(high) / (low)	4.8 km/hr (2.8 mph) / 3.0 km/hr (2.0 mph)
Gradeability	35° (70 %)
Parking brake	Multi wet disc

Control

Pilot pressure operated joysticks and pedals with detachable lever provide almost effortless and fatigueless operation.

Pilot control	Two joysticks with one safety lever (LH): Swing and arm, (RH): Boom and bucket(ISO)
Traveling and steering	Two levers with pedals
Engine throttle	Electric, Dial type
External lights	Two lights mounted on the boom one under the battery box

Swing system

Swing motor	Axial piston motor
Swing reduction	Planetary gear reduction
Swing circuit lubrication	Grease-bathed
Swing brake	Multi wet disc
Swing speed	9.0 rpm

Coolant & Lubricant capacity

(refilling)	liter	US gal	UK gal
Fuel tank	520	137.4	114.4
Engine coolant	45.0	11.9	9.9
Engine oil	31.7	8.4	7.0
Swing device	8.0	1.6	1.3
Final drive(each)	5.5	1.8	1.5
Hydraulic system	380	100.4	83.6
Hydraulic tank	230	60.8	50.6

Undercarriage

X-leg type center frame is integrally welded with reinforced box-section track frames. The undercarriage includes lubricate rollers, idlers, track adjusters with shock absorbing spring and sprockets, and track chain with double or triple grouser shoes.

Center frame	X - leg type
Track frame	Pentagonal box type
No. of shoes on each side	51
No. of carrier roller on each side	2
No. of track roller on each side	9
No. of track guard on each side	2

Operating weight (approximate)

Operating weight, including 6,500m (21' 4") boom, 3,200 m (10' 6") arm, SAE heaped 1.62 m³ (2.12 yd³) backhoebucket, lubricant, coolant.

Major component weight	
Upperstructure	8,500 kg (18,740 lb)
Counterweight	6,500 kg (14,330 lb)
Boom (with arm cylinder)	3,780 kg (8,330 lb)

Operating weight

Shoes(Triple grouser) mm(in)	Operating weight kg(lb)	Ground pressure kgf/cm ² (psi)
※ 600(24)	36,100(79,590)	0.64(9.10)
700(28)	36,500(80,600)	0.56(7.96)
750(30)	36,725(81,000)	0.52(7.39)
800(32)	36,950(81,500)	0.49(6.97)
900(36)	37,400(82,500)	0.44(6.26)

※ Standard equipment

Buckets



Capacity m ³ (yd ³)		Width mm (in)		Weight kg(lb)	Recommendation mm(ft.in)						
SAE heaped	CECE heaped	Without side cutters	With side cutters		Boom	※ 6,500 (21' 4")			6,150 (20' 2")	8,600 (28' 3")	
					Arm	2,500 (8' 2")	※ 3,200 (10' 6")	3,900 (12' 10")	4,300 (14' 1")	2,500 (8' 2")	5,100 (16' 9")
1.15(1.50)	1.00(1.31)	1,090(42.9)	1,220(48.0)	1,030(2,270)	●	●	●	●	●	●	▲
1.46(1.91)	1.27(1.66)	1,380(54.3)	1,510(59.4)	1,170(2,580)	●	●	●	■	●	●	▲
※ 1.62(2.12)	1.40(1.83)	1,440(56.7)	1,570(61.8)	1,280(2,820)	●	●	■	■	●	●	-
1.86(2.43)	1.60(2.1)	1,620(63.8)	1,750(68.9)	1,390(3,060)	●	●	■	▲	●	●	-
2.10(2.75)	1.80(2.4)	1,810(71.3)	1,940(76.4)	1,520(3,350)	■	■	▲	-	●	●	-
2.32(3.03)	2.00(2.62)	1,990(78.3)	2,120(83.5)	1,760(3,880)	▲	▲	▲	-	■	■	-
■ 1.62(2.12)	1.40(1.83)	1,540(60.6)	-	1,570(3,460)	●	■	▲	▲	●	●	-
● 1.44(1.88)	1.27(1.66)	1,280(50.4)	-	1,565(3,450)	●	●	■	▲	●	●	-
● 1.62(2.12)	1.40(1.83)	1,545(60.8)	-	1,610(3,550)	●	■	▲	▲	●	●	-
● 1.86(2.43)	1.60(2.1)	1,725(67.9)	-	1,710(3,770)	■	▲	-	-	■	■	-

※ : Standard backhoe bucket
 ■ : Heavy-duty
 ● : Rock bucket-Heavy duty

● : Applicable for materials with density of 2,000 kg / m³ (3,370 lb/ yd³) or less
 ■ : Applicable for materials with density of 1,600 kg / m³ (2,700 lb/ yd³) or less
 ▲ : Applicable for materials with density of 1,100 kg / m³ (1,850 lb/ yd³) or less

Backhoe attachmet

Boom and arms are of all-welded, low-stress, full-box section design. 6,500mm(21' 4") 6,150mm(20' 2"), 8,600(28' 3")boom and 2,500mm(8' 2"), 3,200mm(10' 6"), 3,900mm(12' 10"), 4,300mm(14' 1") 5,100mm(16' 9")arms are available. Buckets are all-welded, high-strength steel implements.



Digging force

Arm	Length	mm(ft.in)	2,500 (8' 2")	※ 3,200 (10' 6")	3,900 (12' 10")	4,300 (14' 1")	Remark
			Weight	kg(lb)	1,930 (4,260)	1,960 (4,320)	
Bucket digging force	SAE	kN	201.0 [219.3]	201.0 [219.3]	201.0 [219.3]	201.0 [219.3]	[] : Power Boost
		kgf	20500 [22360]	20500 [22360]	20500 [22360]	20500 [22360]	
	lbf	45190 [49300]	45190 [49300]	45190 [49300]	45190 [49300]		
	ISO	kN	228.5 [249.3]	228.5 [249.3]	228.5 [249.3]	228.5 [249.3]	
Arm crowd force	SAE	kN	184.4 [201.1]	152.0 [165.8]	135.3 [147.6]	124.5 [135.9]	[] : Power Boost
		kgf	18800 [20510]	15500 [16910]	13800 [15050]	12700 [13850]	
	lbf	41450 [45220]	34170 [37280]	30420 [33190]	28000 [30550]		
	ISO	kN	192.2 [209.7]	156.9 [171.2]	139.3 [151.9]	128.5 [140.1]	
ISO	kgf	19600 [21380]	16000 [17450]	14200 [15490]	13100 [14290]		
	lbf	43210 [47140]	35270 [38480]	31310 [34160]	28880 [31510]		

Note : Arm weight including bucket cylinder and linkage.

※ Standard arm

Dimensions & Working ranges



Dimensions

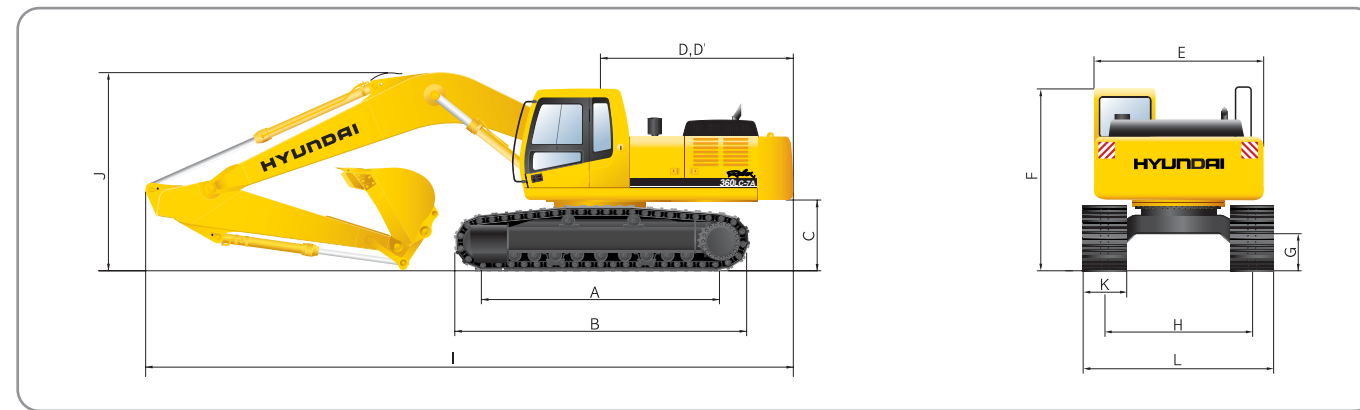

mm (ft · in)

A	Tumbler distance	4,340 (14' 3")
B	Overall length of crawler	5,280 (17' 4")
C	Ground clearance of counterweight	1,290 (4' 3")
D	Tail swing radius	3,415 (11' 2")
D'	Rear-end length	3,350 (11' 0")
E	Overall width of upperstructure	2,980 (9' 9")
F	Overall height of cab	3,175 (10' 5")
G	Min. ground clearance	550 (1' 10")
H	Track gauge	2,740 (9' 0")

mm (ft · in)

	Boom length	※ 6,500 (21' 4")					6,150 (20' 2")	8,600 (28' 3")
	Arm length	2,500 (8' 2")	※ 3,200 (10' 6")	3,900 (12' 10")	4,300 (14' 1")	2,500 (8' 2")	5,100 (16' 9")	
I	Overall length	11,240 (36' 11")	11,120 (36' 6")	11,070 (36' 4")	11,050 (36' 3")	10,880 (35' 8")	13,070 (42' 11")	
J	Overall height of boom	3,700 (12' 2")	3,440 (11' 3")	3,870 (12' 8")	4,270 (14' 0")	3,830 (12' 7")	4,830 (15' 10")	
K	Track shoe width	※ 600 (24")	700 (28")	750 (30")	800 (32")	900 (36")		
L	Overall width	3,340 (10' 11")	3,440 (11' 3")	3,490 (11' 5")	3,540 (11' 7")	3,640 (11' 11")		

※ Standard Equipment



Working ranges

mm (ft · in)

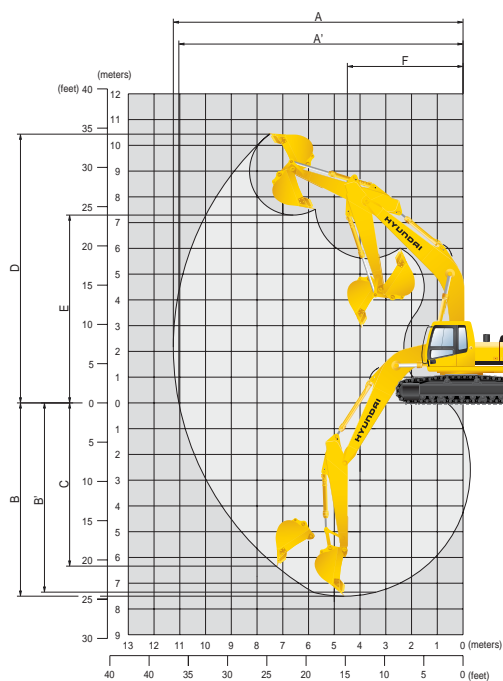

	Boom length	※ 6,500 (21' 4")					6,150 (20' 2")	8,600 (28' 3")
	Arm length	2,500 (8' 2")	※ 3,200 (10' 6")	3,900 (12' 10")	4,300 (14' 1")	2,500 (8' 2")	5,100 (16' 9")	
A	Max. digging reach	10,720 (35' 2")	11,250 (36' 11")	11,870 (38' 11")	12,380 (39' 12")	10,330 (33' 11")	15,300 (50' 2")	
A'	Max. digging reach on ground	10,490 (34' 5")	11,000 (36' 1")	11,670 (38' 3")	12,180 (40' 0")	10,100 (33' 2")	15,120 (49' 7")	
B	Max. digging depth	6,800 (22' 4")	7,500 (24' 7")	8,200 (26' 11")	8,600 (28' 3")	6,440 (21' 2")	11,210 (36' 9")	
B'	Max. digging depth (8' level)	6,620 (21' 9")	7,350 (24' 1")	8,070 (26' 6")	8,480 (27' 10")	6,260 (20' 6")	11,100 (36' 5")	
C	Max. vertical wall digging depth	5,940 (19' 6")	6,340 (20' 10")	7,040 (23' 1")	7,550 (24' 9")	5,500 (18' 1")	10,070 (33' 0")	
D	Max. digging height	10,470 (34' 4")	10,430 (34' 3")	10,650 (34' 11")	11,210 (36' 9")	10,200 (33' 6")	13,160 (43' 2")	
E	Max. dumping height	7,270 (23' 10")	7,290 (23' 11")	7,510 (24' 8")	8,030 (26' 4")	7,020 (23' 0")	9,990 (32' 9")	
F	Min. swing radius	4,630 (14' 2")	4,560 (14' 12")	4,550 (14' 11")	4,570 (14' 12")	4,320 (14' 2")	6,040 (19' 10")	

※ Standard Equipment

Lifting Capacities



Lifting capacities



Rating over-front



Rating over-side or 360 degree

• Boom : 6.15m (20' 2") • Arm : 2.5 m (8' 2") • Bucket : 1.62 m³ (2.12 yd³) SAE heaped • Shoe : 600mm(24") triple grouser with 6,500kg (14,330 lb) CW

Load point height m(ft)	Load radius	Load radius						At max. reach				
		3.0 m(10.0 ft)		4.5 m(15.0 ft)		6.0 m(20.0 ft)		7.5 m(25.0 ft)		Capacity	Reach	
		Rating over-front	Rating over-side or 360 degree	Rating over-front	Rating over-side or 360 degree	Rating over-front	Rating over-side or 360 degree	Rating over-front	Rating over-side or 360 degree	kg (lb)	m (ft)	
9.0 m 30.0 ft	kg lb									*7640 *16840	*7640 *16840	6.65 (21.8)
7.5 m 25.0 ft	kg lb									*7520 *16580	5970 13160	8.02 (26.3)
6.0 m 20.0 ft	kg lb					*8660 *19090	*8660 *19090	*6540 *14420	6530 14400	*7580 *16710	4800 10580	8.88 (29.1)
4.5 m 15.0 ft	kg lb	*18380 *40520	*18380 *40520	*12260 *27030	*12260 *27030	*9890 *21800	9350 20610	*8740 *19270	6330 13960	7200 15870	4190 9240	9.38 (30.8)
3.0 m 10.0 ft	kg lb			*15570 *34330	13710 30230	*11460 *25260	8720 19220	*9500 *20940	6030 13290	6790 14970	3890 8580	9.58 (31.4)
1.5 m 5.0 ft	kg lb			*18030 *39750	12630 27840	*12850 *28330	8150 17970	10010 22070	5730 12630	6750 14880	3830 8440	9.52 (31.2)
Ground Line	kg lb	*13370 *29480	*13370 *29480	*18930 *41730	12120 26720	*13670 *30140	7770 17130	9760 21520	5500 12130	7090 15630	4010 8840	9.19 (30.2)
-1.5 m -5.0 ft	kg lb	*20990 *46270	*20990 *46270	*18580 *40960	11990 26430	*13710 *30230	7610 16780	9650 21270	5410 11930	7990 17610	4540 10010	8.53 (28.0)
-3.0 m -10.0 ft	kg lb	*23670 *52180	*23670 *52180	*17040 *37570	12100 26680	*12670 *27930	7650 16870			*8470 *18670	5730 12630	7.47 (24.5)
-4.5 m -15.0 ft	kg lb	*18590 *40980	*18590 *40980	*13590 *29960	12520 27600							

• Boom : 6.5m (21' 4") • Arm : 2.5 m (8' 2") • Bucket : 1.62 m³ (2.12 yd³) SAE heaped • Shoe : 600mm(24") triple grouser with 6,500kg (14,330 lb) CW

Load point height m(ft)	Load radius	Load radius						At max. reach				
		3.0 m(10.0 ft)		4.5 m(15.0 ft)		6.0 m(20.0 ft)		7.5 m(25.0 ft)		Capacity	Reach	
		Rating over-front	Rating over-side or 360 degree	Rating over-front	Rating over-side or 360 degree	Rating over-front	Rating over-side or 360 degree	Rating over-front	Rating over-side or 360 degree	kg (lb)	m (ft)	
9.0 m 30.0 ft	kg lb									*6900 *15210	*6900 *15210	7.22 (23.7)
7.5 m 25.0 ft	kg lb									*6870 *15150	5190 11440	8.49 (27.9)
6.0 m 20.0 ft	kg lb					*8050 *17750	*8050 *17750	*7580 *16710	6370 14040	*6970 *15370	4240 9350	9.29 (30.5)
4.5 m 15.0 ft	kg lb			*11980 *26410	*11980 *26410	*9400 *20720	8990 19820	*8180 *18030	6110 13470	6550 14440	3720 8200	9.77 (32.1)
3.0 m 10.0 ft	kg lb			*15410 *33970	12960 28570	*11030 *24320	8330 18360	*9020 *19890	5790 12760	6210 13690	3470 7650	9.97 (32.7)
1.5 m 5.0 ft	kg lb			*17780 *39200	12000 26460	*12460 *27470	7780 17150	9750 21500	5490 12100	6180 13620	3430 7560	9.91 (32.5)
Ground Line	kg lb			*18570 *40940	11650 25680	*13320 *29370	7450 16420	9520 20990	5280 11640	6490 14310	3610 7960	9.59 (31.5)
-1.5 m -5.0 ft	kg lb	*17800 *39240	*17800 *39240	*18280 *40300	11630 25640	*13480 *29720	7340 16180	9440 20810	5210 11490	7260 16010	4070 8970	8.97 (29.4)
-3.0 m -10.0 ft	kg lb	*23550 *51920	*23550 *51920	*17040 *37570	11830 26080	*12770 *28150	7430 16380			*8130 *17920	5070 11180	7.97 (26.1)
-4.5 m -15.0 ft	kg lb	*19520 *43030	*19520 *43030	*14370 *31680	12280 27070					*7460 *16450	*7460 *16450	6.39 (21.0)

• Boom : 6.5m (21' 4") • Arm : 3.2 m (10' 6") • Bucket : 1.62 m³ (2.12 yd³) SAE heaped • Shoe : 600mm(24") triple grouser with 6,500kg (14,330 lb) CW

Load point height m(ft)	Load radius	Load radius						At max. reach								
		1.5 m(5.0 ft)		3.0 m(10.0 ft)		4.5 m(15.0 ft)		6.0 m(20.0 ft)		7.5 m(25.0 ft)		9.0m(30.0 ft)		Capacity	Reach	
		Rating over-front	Rating over-side or 360 degree	Rating over-front	Rating over-side or 360 degree	Rating over-front	Rating over-side or 360 degree	Rating over-front	Rating over-side or 360 degree	Rating over-front	Rating over-side or 360 degree	Rating over-front	Rating over-side or 360 degree	kg (lb)	m (ft)	
9.0 m 30.0 ft	kg lb													*6020 *13270	*6020 *13270	7.97 (26.1)
7.5 m 25.0 ft	kg lb									*4590 *10120	*4590 *10120			*6110 *13470	4650 10250	9.12 (29.9)
6.0 m 20.0 ft	kg lb									*6710 *14790	6590 14530			*6140 *13540	3860 8510	9.87 (32.4)
4.5 m 15.0 ft	kg lb							*8350 *18410	*8350 *18410	*7420 *16360	6290 13870	*4490 *9900	4440 9790	6020 13270	3410 7520	10.32 (33.9)
3.0 m 10.0 ft	kg lb					*13690 *30180	13640 30070	*10100 *22270	8600 18960	*8370 *18450	5930 13070	*6400 *14110	4260 9390	5710 12590	3180 7010	10.5 (34.4)
1.5 m 5.0 ft	kg lb					*16650 *36710	12420 27380	*11760 *25930	7980 17590	*9330 *20570	5590 12320	7260 16010	4080 8990	5670 12500	3120 6880	10.45 (34.3)
Ground Line	kg lb			*13060 *28790	*13060 *28790	*18210 *40150	11800 26010	*12930 *28510	7540 16620	9560 21080	5320 11730	7100 15650	3930 8660	5900 13010	3240 7140	10.14 (33.3)
-1.5 m -5.0 ft	kg lb	*13680 *30160	*13680 *30160	*17490 *38560	*17490 *38560	*18550 *40900	11600 25570	*13460 *29670	7330 16160	9400 20720	5170 11400			6480 14290	3590 7910	9.57 (31.4)
-3.0 m -10.0 ft	kg lb	*17850 *39350	*17850 *39350	*22770 *50200	*22770 *50200	*17870 *39400	11660 25710	*13210 *29120	7310 16120	9400 20720	5180 11420			7700 16980	4320 9520	8.65 (28.4)
-4.5 m -15.0 ft	kg lb	*22570 *49760	*22570 *49760	*22590 *49800	*22590 *49800	*16000 *35270	11960 26370	*11870 *26170	7510 16560					*8000 *17640	5980 13180	7.25 (23.8)
-6.0 m -20.0 ft	kg lb					*11900 *26230	*11900 *26230									

NOTES

1. Lifting capacity is based on SAE J1097, ISO 10567.

2. Lifting capacity of the Robex Series does not exceed 75% of tipping load with the machine on firm, level ground or 87% of full hydraulic capacity.

3. The load point is a hook (standard equipment) located on the back of the bucket.

4. (*) indicates load limited by hydraulic capacity.

